



PEAKFORM SUSPENSION SYSTEMS

Inspiring Great Spaces™

**Armstrong**®

CEILING SYSTEMS

# THE PEAKFORM RANGE: WHERE INNOVATION MEETS PERFORMANCE



**PeakForm** is a comprehensive range of suspended ceiling grid solutions designed to meet most commercial design requirements:

- General Application: Including PRELUDE XL<sup>2</sup> 24mm and SUPRAFINE XL<sup>2</sup> 15mm Tee Grid systems.
- Designer Applications: Including the minimalist SILHOUETTE 15 XL<sup>2</sup> Steel Exposed Slotted Grid.

## Axiom Perimeter Solutions

**PeakForm Grid Systems** are made complete with a Comprehensive range of Axiom Perimeter Solutions, including: Wall angles, Trims, Transitions, Pelmet and Accessories.

## PeakForm Grid Profiles

**PeakForm** is an innovative design for Main Bars and Cross Runners. The taller **PeakForm** profiles are engineered to create a stronger, more stable suspension system making installation both faster and easier.

**PeakForm** Main Bars feature a firm, quick and easy assembled Main Bar to Main Bar / bulb to-bulb connection.

The staked-on Superlock joiner clip allows for Main Bars to be disconnected and reconnected laterally in low clearance areas or in the middle of a room. Superlock is an industry first staked-on clip for Main Bars which provide tighter, secure bulb-to-bulb connections; connections are confirmed by an audible click.



## Thin gauge technology:

A lighter carton weight enables easier handling on site, plus the added benefit of the **PeakForm** bulb allows easy cutting of the grid.



## Physical detail

All grid sections are made from double-web galvanised steel with a surface finish of baked polyester paint.

## Rotary Stitched for strength

All **PeakForm** components feature a unique "rotary stitched" construction. The two metal layers of the vertical web are mechanically locked together in a sophisticated in-line process. Stitching enhances the torsional resistance and general "feel" of the **PeakForm** components.

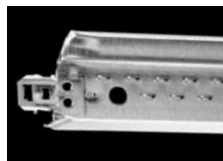

## PeakForm "click" installation

**PeakForm** Cross Runners in both 24mm and 15mm widths feature an advanced stab system that locates with an audible "click", ensuring a solid installation at all times. The "stab" end details are precision stamped from a separate piece of high grade steel providing increased accuracy and speed of installation.

Cross Runners are inserted to the right of each other through the Main Bar slots and easily pushed home.

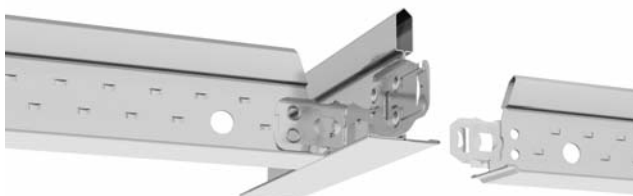

## Sustainability

Armstrong **PeakForm** suspension systems contain 25% recycled content and can be fully recycled at the end of life.

**PeakForm** grid systems are modular and can be disassembled and reused.

**PeakForm** suspension systems meet the requirements of Australian Standard 2785-2000 "Suspended Ceilings Design and Installation" and are designed for use with a wide variety of Armstrong ceiling products including: mineral and soft fibre, metal, wood and special solutions.

## Compliant with Australian & New Zealand Standards

**PeakForm** suspension systems meet the requirements of AS/NZS 2785-2000 "Suspended Ceilings Design and Installation" and are designed for use with a wide variety of Armstrong ceiling products including: mineral and soft fibre, metal, wood, plasterboard and other special panels.

For Seismic  
Design support  
please contact  
your local  
Armstrong  
office.

# PEAKFORM PRELUDE 24 XL<sup>2</sup>

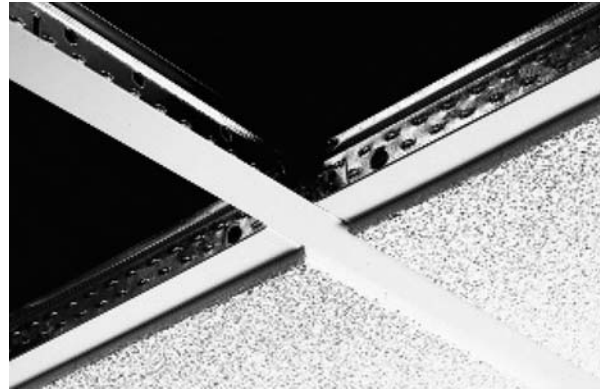

PeakForm PRELUDE 24 XL<sup>2</sup> suspension system is a robust, general purpose, exposed 24mm “tee” grid, suitable for square edge and tegular edge ceiling panels.

## Main Bar: PRELUDE 24 XL<sup>2</sup> with Superlock Clip (bulb-to-bulb connection)

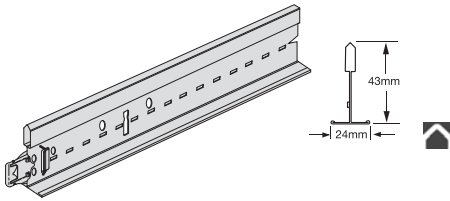

Item Number	Dimensions			Rout Centres mm	Content / Carton		Weight / Carton kg
	length (mm)	height (mm)	width (mm)		pcs	lm	
HBP 73 40 42	3600	43	24	100	20	72	22

## Cross Runner: PRELUDE 24 XL<sup>2</sup> (stab system, override)

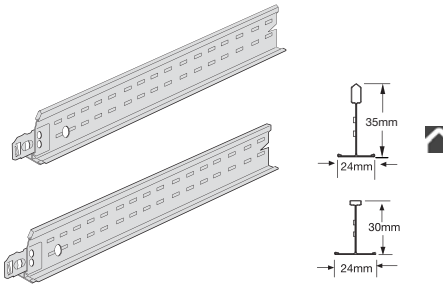

Item Number	Dimensions			Rout Centres mm	Content / Carton		Weight / Carton kg
	length (mm)	height (mm)	width (mm)		pcs	lm	
HBP 31 30 52	1200	35	24	300	60	72	21
HBP 31 20 22	600	30	24	—	60	36	10

## Section Drawings

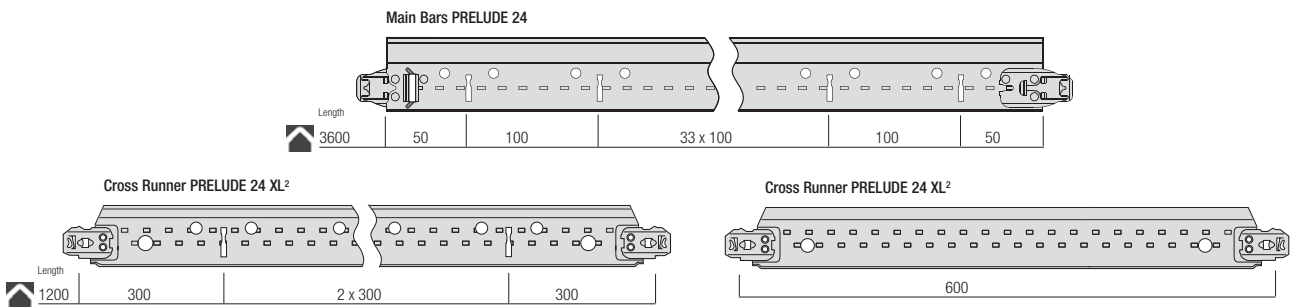

## System Drawing and Installation (Typical modules are 1200 x 600mm and 600 x 600mm. Special sizes available upon request.)

Standard lay-in installation of 24mm exposed suspension system using Board or Tegular tiles.

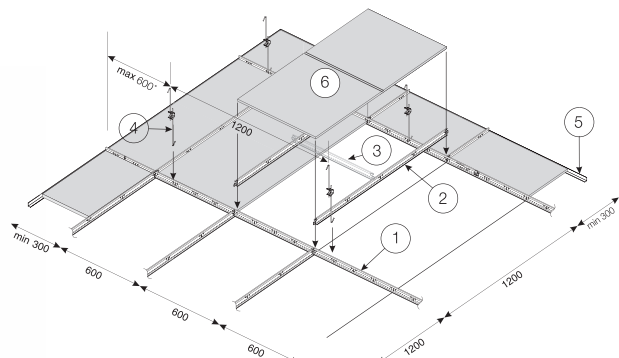

# PERIMETER TRIMS AND ACCESSORIES

## Perimeter Trims

Item Number	Description	Length (mm)	Content / Carton pcs / lm	Weight / Carton kg
HBPT1932H HBP784003	<b>Steel Perimeter Trims: Roll Formed and Prepainted</b>			
	Long Leg Wall Angle	3600	30	21
	Shadow Line Wall Angle	3600	30	20
AL008RCPGW AL009RCPGW ALBULK3600GW	<b>Aluminium Perimeter Trims: Extruded and Powdercoated</b>			
	Wall Angle for Roll In Clip Attachment	3600	20	14
	Shadow Line Wall Angle for Roll In Clip Attachment	3600	20	14
	Bulkhead Trim (suits both 10mm and 13mm Pb)	3600	6	6

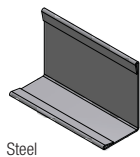

Steel

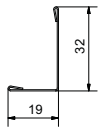

HBPT1932H

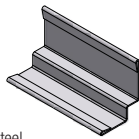

Steel

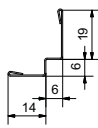

HBP 784003

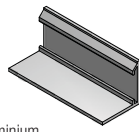

Aluminium

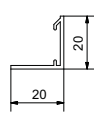

AL008RCPGW

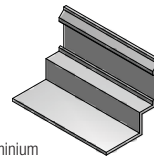

Aluminium

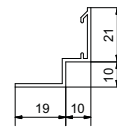

AL009RCPGW

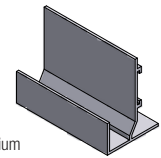

Aluminium

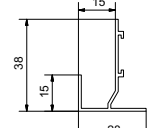

ALBULK3600GW

## Suspension & Accessories

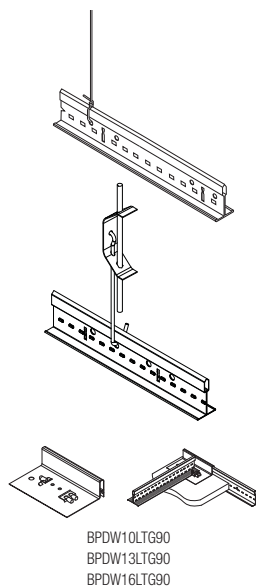

BPDW10LTG90  
BPDW13LTG90  
BPDW16LTG90

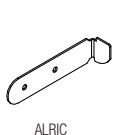

ALRIC



ARM-051



Trclip and threaded rod/nut



SCPF

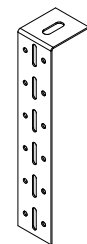

DWDFC

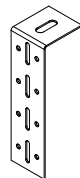

DWDFC120

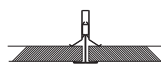

BPUHDCA

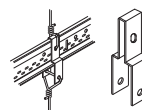

BPDLC



274



188



247

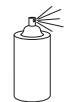

TOUCH UP  
PAINT



254

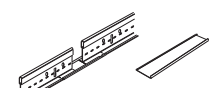

HBPGM1249

Item Number	Description	Dimensions length (mm)	Content / Carton pcs	Weight / Carton kg
SCPF	Hook Suspension Clip for 5mm Rod	165	100	2.2
ARM-051	Direct Fix Clip	175	100	2.6
Trclip	Suspension Clip for 6mm Threaded Rod	80	100	2.0
M6 Rod	6mm Threaded Rod	1200	50	11.0
M6 Nuts	6mm nuts for Threaded Rod	-	200	0.4
BPDLC	Direct Load Ceiling Clip	80	250	5.5
BPUHDCA	Universal Hold Down Clip	-	1000	4.0
ALRIC	Roll In Clip	65	100	5.0
ROD 5mm	5mm Suspension Rod	4000	40	24.2
SR2536	2.5mm Suspension Wire	3600	160	25.0
188	Angle Bracket	47 x 47	100	1.2
247	Suspension Rod Angle Bracket	55	100	2.1
274	Suspension Rod Bracket	80	100	2.1
254	5mm ROD joiner spring adjustable	-	100	0.9
HBPGM1249	Expansion Sleeve to suite 24mm grid	100	100	5.0
BPDW10LTG90	Drywall Transition Clip suits 10mm Plasterboard	-	200	11.0
BPDW13LTG90	Drywall Transition Clip suits 13mm Plasterboard	-	200	11.0
BPDW16LTG90	Drywall Transition Clip suits 16mm Plasterboard	-	200	11.0
GPGW	Grid Touch Up Paint (128g net)	-	6	1.3
DWDFC120	120mm L Shape	120	100	5.0
DWDFC	180mm L Shape	180	100	6.5

## Perimeter Detailing Recommendations

### Square Edge Panels

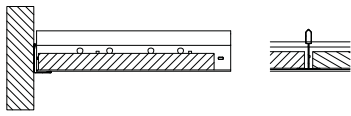

Grid, Wall Angle and "Square Edge Panel" at same level

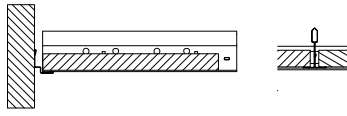

Grid, Wall Angle and "Square Edge Panel" at same level

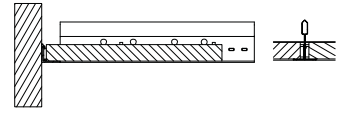

Tee Bar is secured to Wall Angle via Roll In Clip

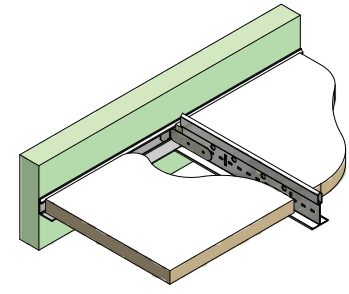
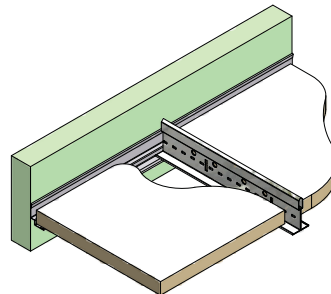
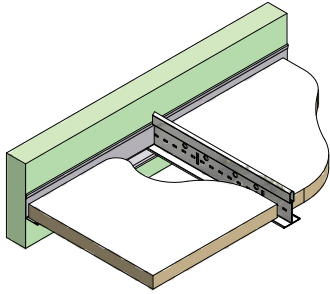

Note: Wall Angles should be fixed to wall at 450mm centres

### Tegular Edge Panels

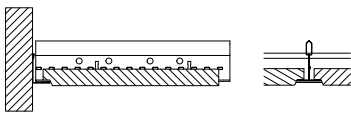

Panel edge is field "tegulated" at Wall Angle

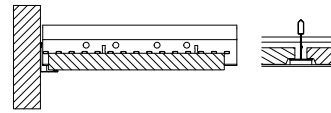

Wall Angle position is dropped to level of face of Panel; Tee Grid is packed at Wall Angle and Panel is square cut at wall angle

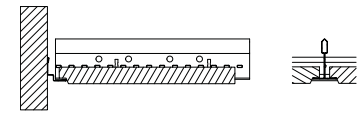

Panel edge is field "tegulated" at Wall Angle

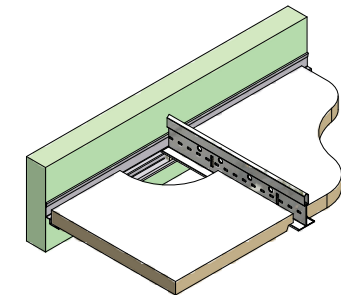
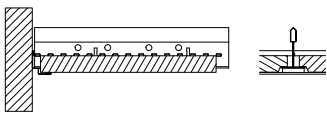

Wall Angle position is dropped to level of face of Panel; Tee Grid is packed at Wall Angle and Panel is square cut at wall angle

For information on Blue Tongue Aluminium Grid and Axiom Perimeter / Pelmet systems, refer to the following brochures.



# SPECIFICATIONS

## Scope

The contractor to furnish all materials, labour and equipment for the erection of the exposed ceiling system where so indicated on the architectural drawings.

## Material

Ceiling suspension shall be Armstrong PeakForm two way exposed, hot dipped galvanised steel system; (either): Prelude XL<sup>2</sup> 24mm Tee, SupraFine XL<sup>2</sup> 15mm Tee, or Silhouette XL<sup>2</sup> 15mm Steel Exposed Slotted "shadowline hat" profiles. All materials supplied by Armstrong meet the requirements of Australian Standard 2785-2000 "Suspended Ceilings Design and Installation".

## Perimeter Detail

Wall Angles should be fixed to wall at 450mm centres. Exposed ceiling grid members intersecting with the Wall Angle or Shadowline Wall Angle, may either be unfixed, or fastened with a Roll In Clip.

## Installation

The Main Bar shall be hung with a 5mm galvanised rod and clip system or 2.5mm wire, accurately levelled. Suspension points shall be spaced at 1200mm\* centres along the Main Bar. Cross Runners shall intersect and be positively locked to Main Bars. Panel Hold Down Clips to be used as required. Hangers, Main

Bars and Cross Runner shall be spaced so as not to exceed the design ceiling load or as may otherwise be required to prevent deflection in excess of 1/360 of the span of the spacers or Main Bars. Where light fittings, air conditioning fixtures etc are to be supported by the grid system, extra hangers may be required. Down bracing to be incorporated in ceiling systems when used externally or adjacent to opening prone to sudden uplift caused by external wind forces.

\* For suspension points greater than 1200mm centres along the Main Bar, contact your local Armstrong representative for load ratings.

## Maximum Fixture Weight

		Main Bar to Main Bar (Fixture / Panel Orientation)			
Main Bar	—				
Cross Runner x 600	—				
Cross Runner x 1200	—				
1. FIXTURE* (mm)		1200 x 600	600 x 600	1200 x 300	600 x 600
2. PLANNING MODULE (mm)		1200 x 1200	1200 x 1200	1200 x 600	1200 x 600
3. HANGER SPACING (mm)		1200	1200	1200	1200
Max Fixture Weight (kgs)					
4. PRELUDE 24		21.2 kg	14.0 kg	17.4 kg	14.0 kg
5. SUPRAFINE 15		27.9 kg	13.9 kg	24.9 kg	13.9 kg
6. SILHOUETTE 15		-	-	-	14.2 kg
		Cross Runner to Cross Runner (Fixture / Panel Orientation)			
Main Bar	—				
Cross Runner x 600	—				
Cross Runner x 1200	—				
1. FIXTURE* (mm)		1200 x 600	600 x 600	600 x 600	1200 x 300
2. PLANNING MODULE (mm)		1200 x 1200	1200 x 1200	600 x 600	1200 x 1200
3. HANGER SPACING (mm)		1200	1200	1200	1200
Max Fixture Weight (kgs)					
4. PRELUDE 24		10.6 kg	10.6 kg	37.5 kg	17.4 kg
5. SUPRAFINE 15		-	-	37.3 kg	-
6. SILHOUETTE 15		-	-	37.9 kg	-

## Connection Strength (SEISMIC)

### Main Bar

HBP734042

### Minimum KGS to Pull Out

Compression / Tension  
174 kg / 133 kg

### Cross Runner

All Cross Runners exceed 136 kg in both compression / tension.

### Loading Parameters

- Main Bars at 1200mm centres
- Cross Runners 1200mm at 600mm spacing
- Suspension points spaced at 1200mm on Main Bar

\*Note: Additional independent support of heavy fixtures should be considered for safety purposes.

The above data is based on 1200mm hanger spacing, board weight of 4.8kg/m<sup>2</sup>, maximum deflection of tees not to exceed 1/360 of the span and suspension system installed in accordance with AS2785-2000.



SCAN\* THIS CODE to learn more about our PeakForm Suspension Systems

\*Download a Free QR code reader app available from Apple store

Armstrong, the Global Leader in Acoustic Ceiling Systems  
[www.armstrongceilings.com.au](http://www.armstrongceilings.com.au)

### NSW

Armstrong World Industries Pty. Ltd.  
99 Derby Street,  
Silverwater NSW 2128  
Telephone: (02) 9748 1588

### VIC/TAS

Armstrong World Industries Pty. Ltd.  
Unit 1, 88 Henderson Road,  
Rowville VIC 3178  
Telephone: (03) 8706 4000

### QLD/NT

Armstrong World Industries Pty. Ltd.  
6 Barrinia Street,  
Slacks Creek QLD 4127  
Telephone: (07) 3809 5565